

2019

ALASKA'S CONSTRUCTION SPENDING FORECAST



ALASKA CONSTRUCTION SPENDING : 2019 FORECAST

Scott Goldsmith

Emeritus Professor of
Economics, Institute of
Social and Economic
Research

May 2, 2019
Anchorage



BY SCOTT GOLDSMITH
INSTITUTE OF SOCIAL AND ECONOMIC RESEARCH
UNIVERSITY OF ALASKA ANCHORAGE



ECONOMIC IMPORTANCE OF THE CONSTRUCTION INDUSTRY

Direct Employment

- Official Count
- Self Employed
- Hidden in Other Industries

Muscle

- Wage
- Backward Linkages
- Statewide Presence

Investment



TOTAL CONSTRUCTION: SPENDING CHANGE: MILLION \$

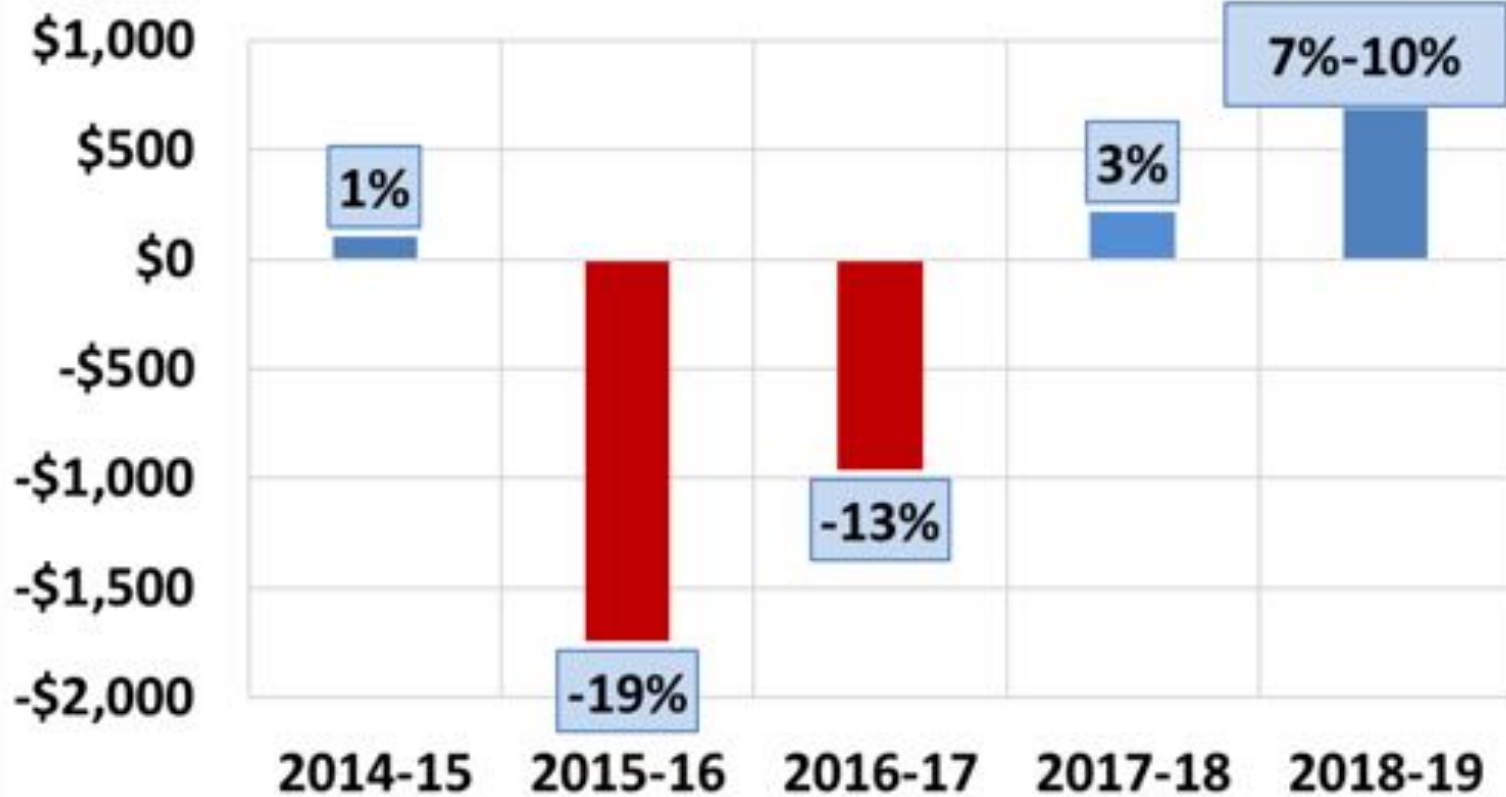

2019 CONSTRUCTION SPENDING:

\$7.22 BILLION

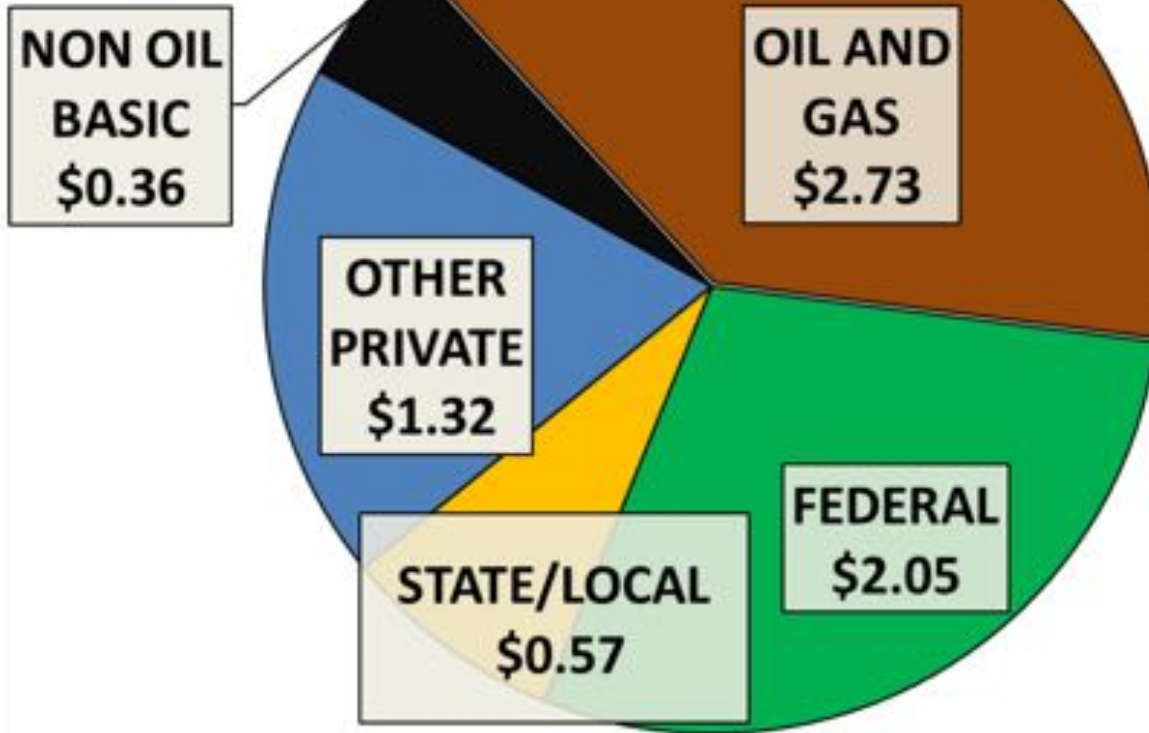

CONSTRUCTION SPENDING (Mill \$)

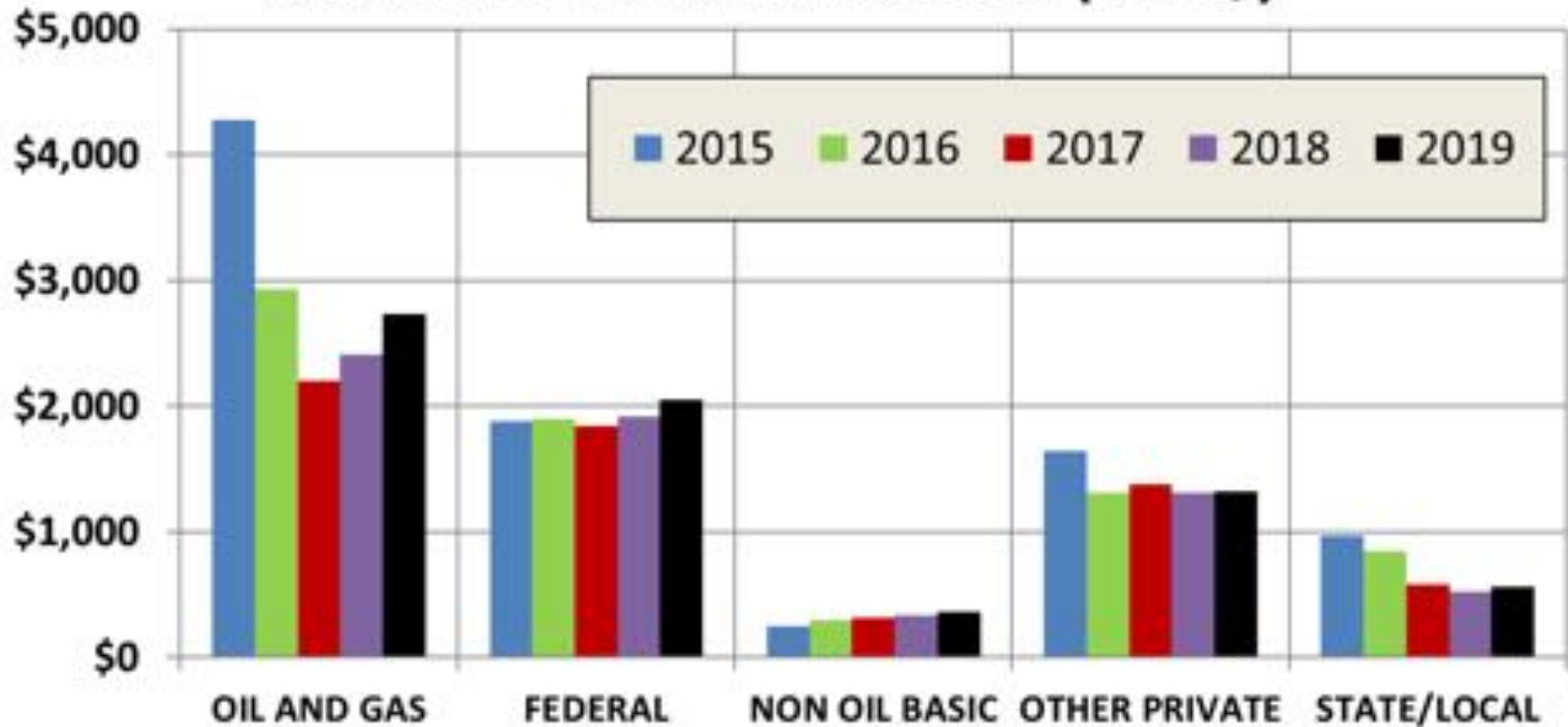

ECONOMIC DRIVERS



PETROLEUM

\$ 2,730

+13%



Nanushuk in NPRA



National and Global Petroleum Assessment

Assessment of Undiscovered Oil and Gas Resources in the Cretaceous Nanushuk and Torok Formations, Alaska North Slope, and Summary of Resource Potential of the National Petroleum Reserve in Alaska, 2017

The U.S. Geological Survey estimated mean undiscovered, technically recoverable resources of 8.7 billion barrels of oil and 25 trillion cubic feet of natural gas (associated and nonassociated) in conventional accumulations in the Cretaceous Nanushuk and Torok Formations in the National Petroleum Reserve in Alaska, adjacent State and Native lands, and State waters. The estimated undiscovered oil resources in the Nanushuk and Torok Formations are significantly higher than previous estimates, owing primarily to recent, larger than anticipated oil discoveries.

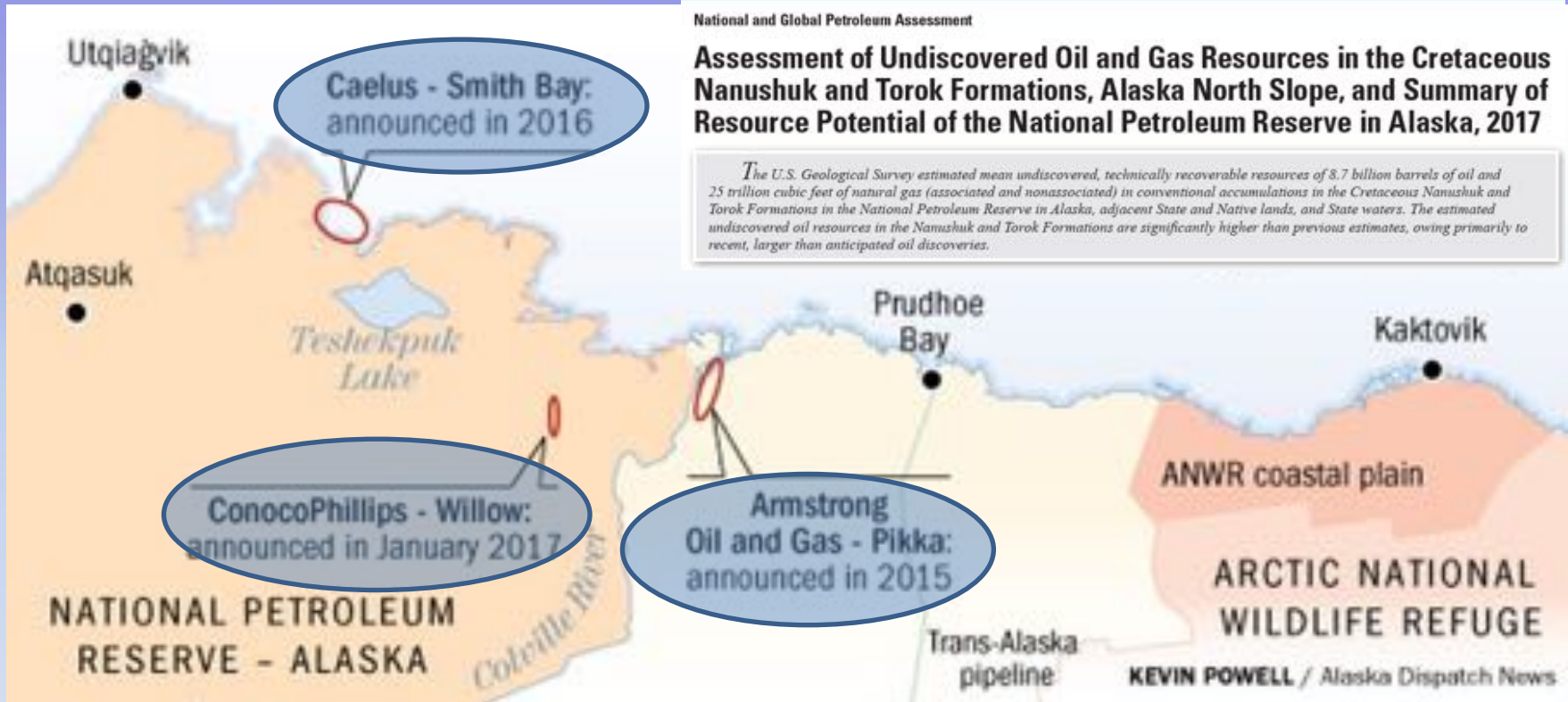

8.7 Billion Barrels of Recoverable Oil!



FEDERAL CIVILIAN



**Transportation / Health Care /
Misc Grants / Procurement**

\$ 1,291

+4%



HIGHWAYS



\$ 682

+6%



AIRPORTS, PORTS, FERRY, RR



\$ 424

+3%



OTHER FEDERAL

GAO

United States Government Accountability Office
Report to Congressional Addressees and
the Alaska Federation of Natives

August 2005

ALASKA NATIVE VILLAGES

Recent Federal
Assistance Exceeded
\$3 Billion, with Most
Provided to Regional
Nonprofits



GAO-05-719



\$ 185

+3%



EXCLUDES HOUSING GRANTS



CORPS OF ENGINEERS

Missile Defense / F35 Bed-down



\$ 390

+18%



F-35 PROJECTED CONSTRUCTION SCHEDULE



CORPS OF ENGINEERS

Environmental, Interagency, Civil Works

\$ 320

+7%

Erosion Protection at Shishmaref



U.S. Coast Guard
in Arctic



Remediation at
Umiat Test Well #9



MINING, TOURISM, SEAFOOD, TIMBER, AIR CARGO



\$ 360

+8%



MAJOR MINES



SUPPORT SECTORS



Economic Forecast

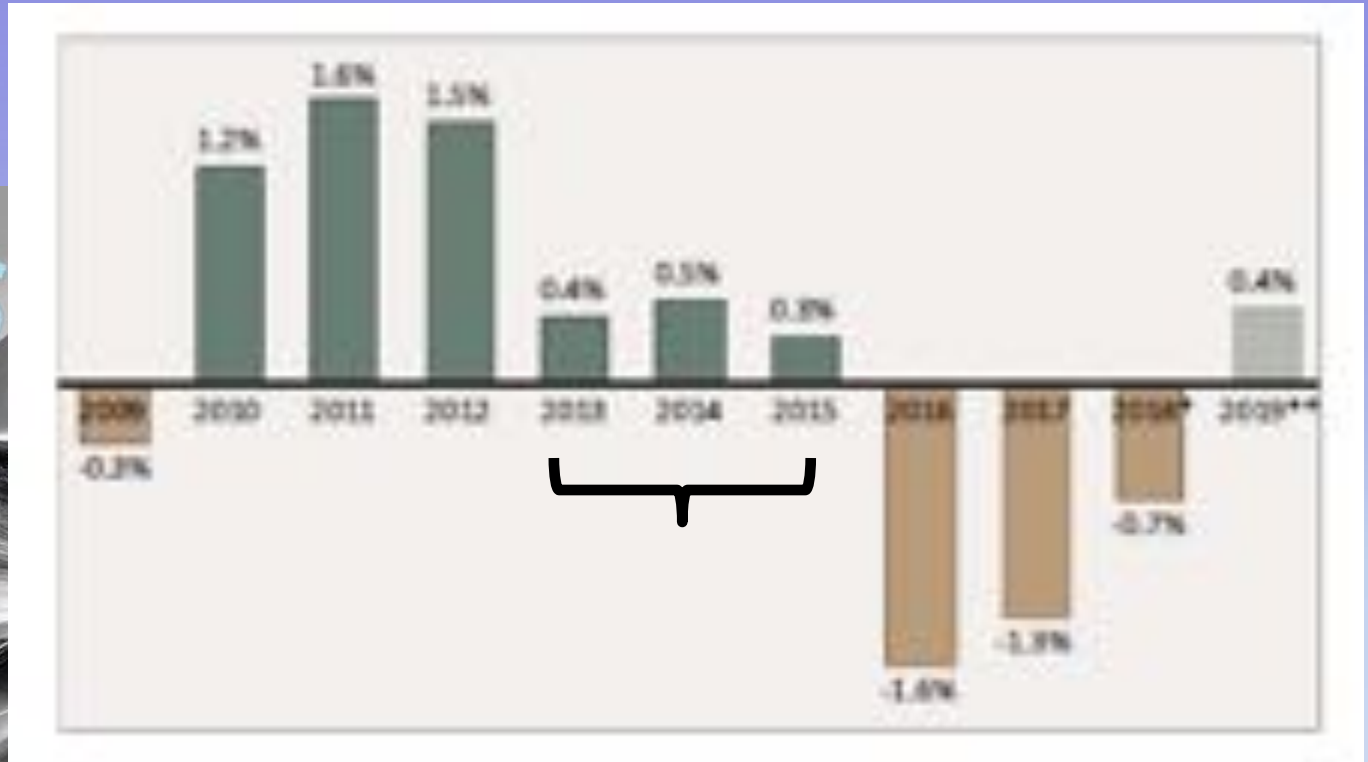

UTILITIES

\$ 459

+2%



HEALTH CARE

\$ 283

+3%



OFFICE, RETAIL, WAREHOUSE, MISC.

\$ 255

-4%



RESIDENTIAL

\$ 325

-



STATE GOVERNMENT (Excluding Grants from Feds)



\$ 317

+9%



Education



\$ 248

+6%



Other State Government



\$ 69

+25%



STATE AGENCIES

- Alaska Aerospace Corporation (AAC)
- Alaska Energy Authority (AEA)
- Alaska Gasline Development Corporation (AGDC)
- Alaska Housing Finance Corporation (AHFC)
- Alaska Industrial Development and Export Authority (AIDEA)
- Alaska Mental Health Trust Authority (AMHTA)
- Alaska Municipal Bond Bank Authority (AMBBA)
- Alaska Railroad Corporation (ARC)
- Alaska Seafood Marketing Institute (ASMI)
- Alaska Student Loan Corporation (ASLC)



LOCAL GOVERNMENT

\$ 294

+3%



EARTHQUAKE



SPENDING GROWTH : MOSTLY FROM 5 SOURCES

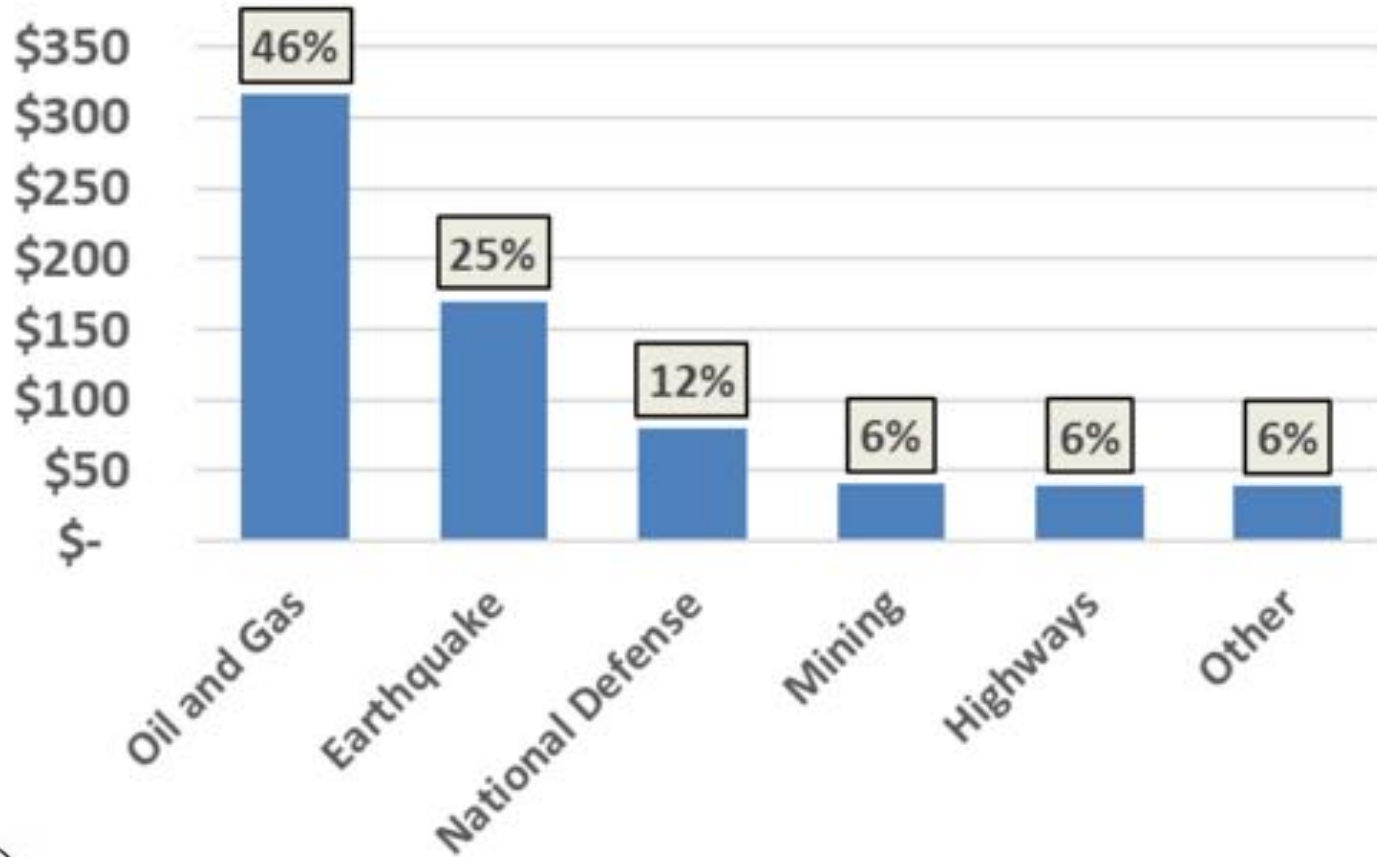

HOW ARE WE DOING?

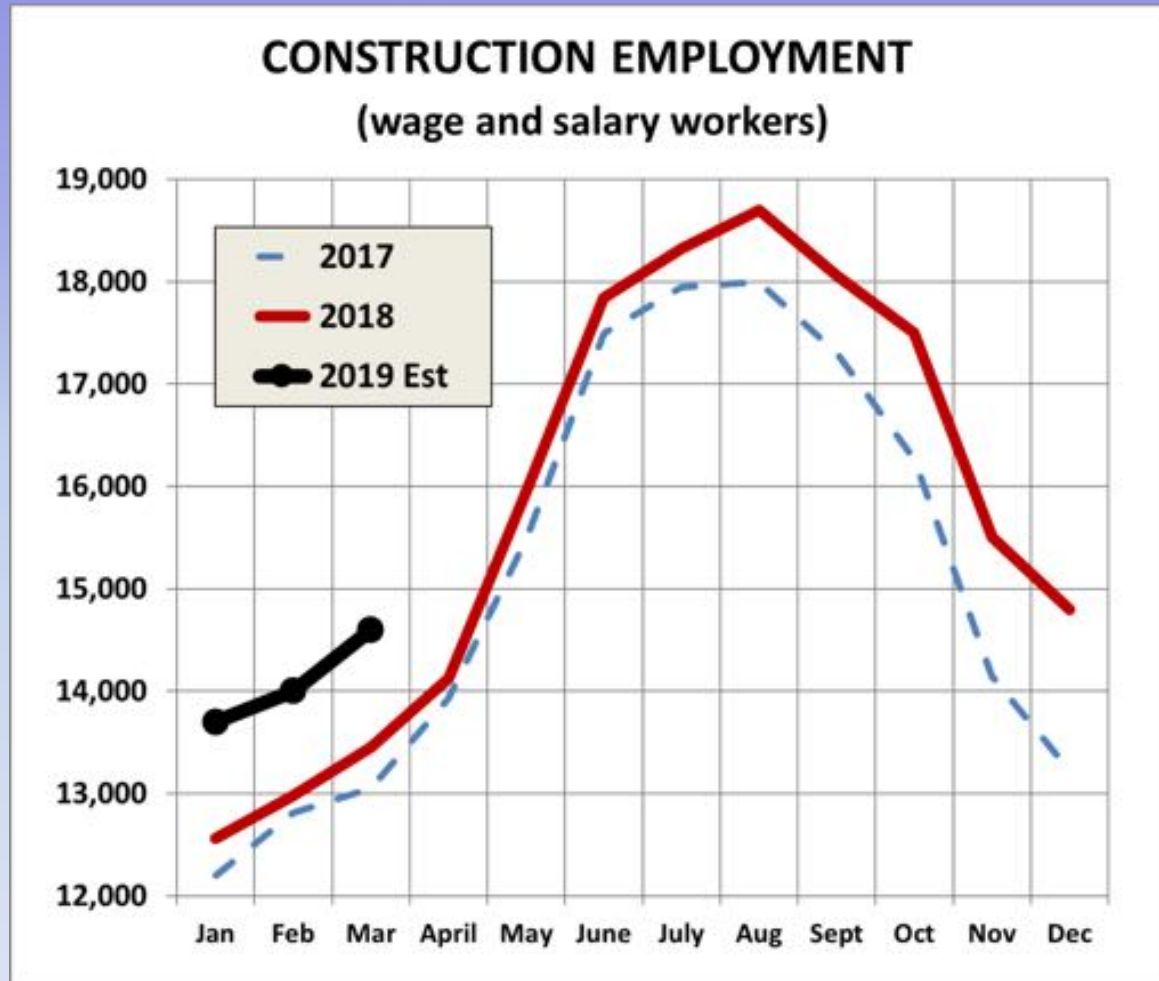

PETROLEUM CAPEX (MILLION \$)

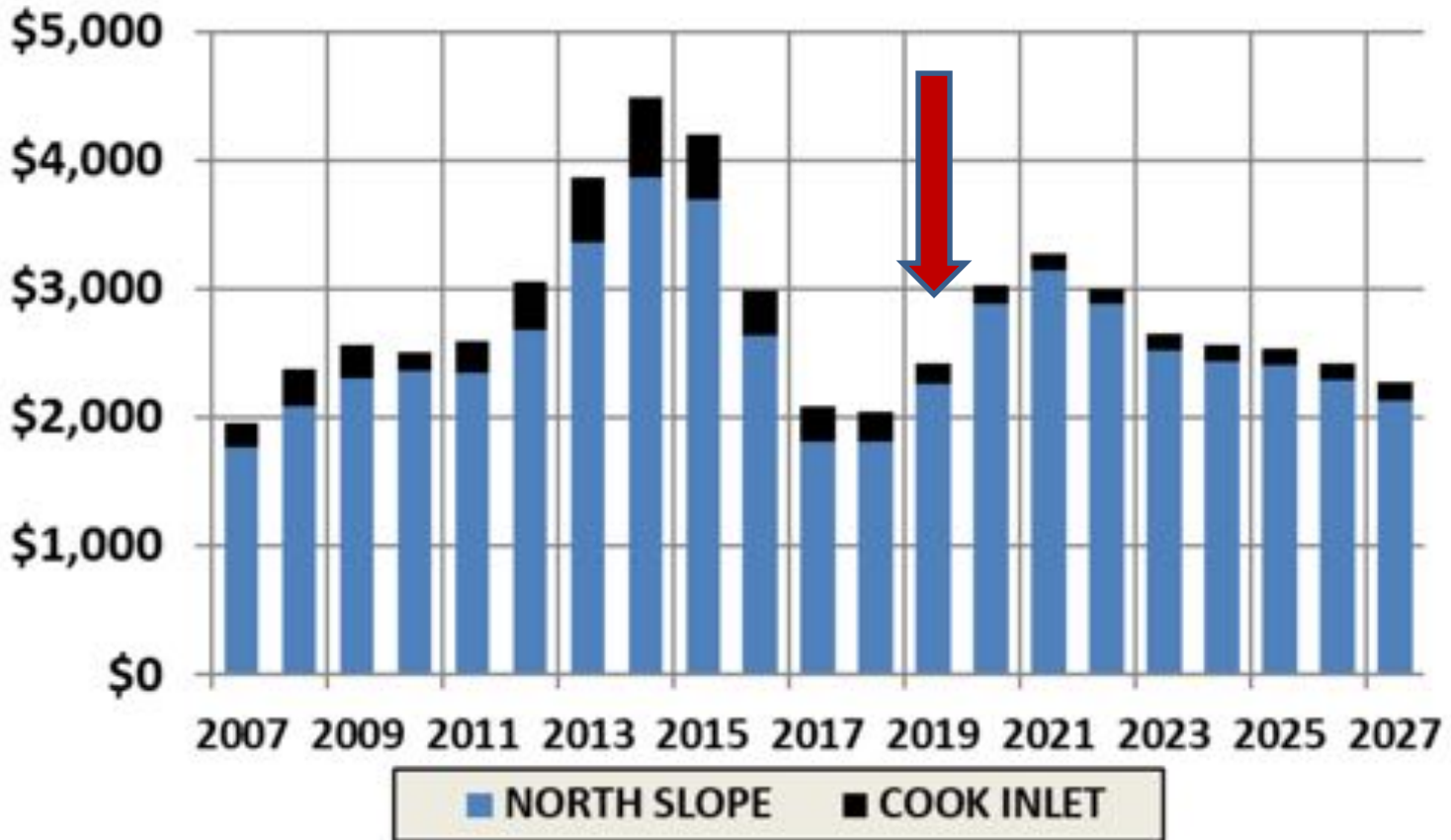

LRDR DESIGN & CONSTRUCTION SCHEDULE

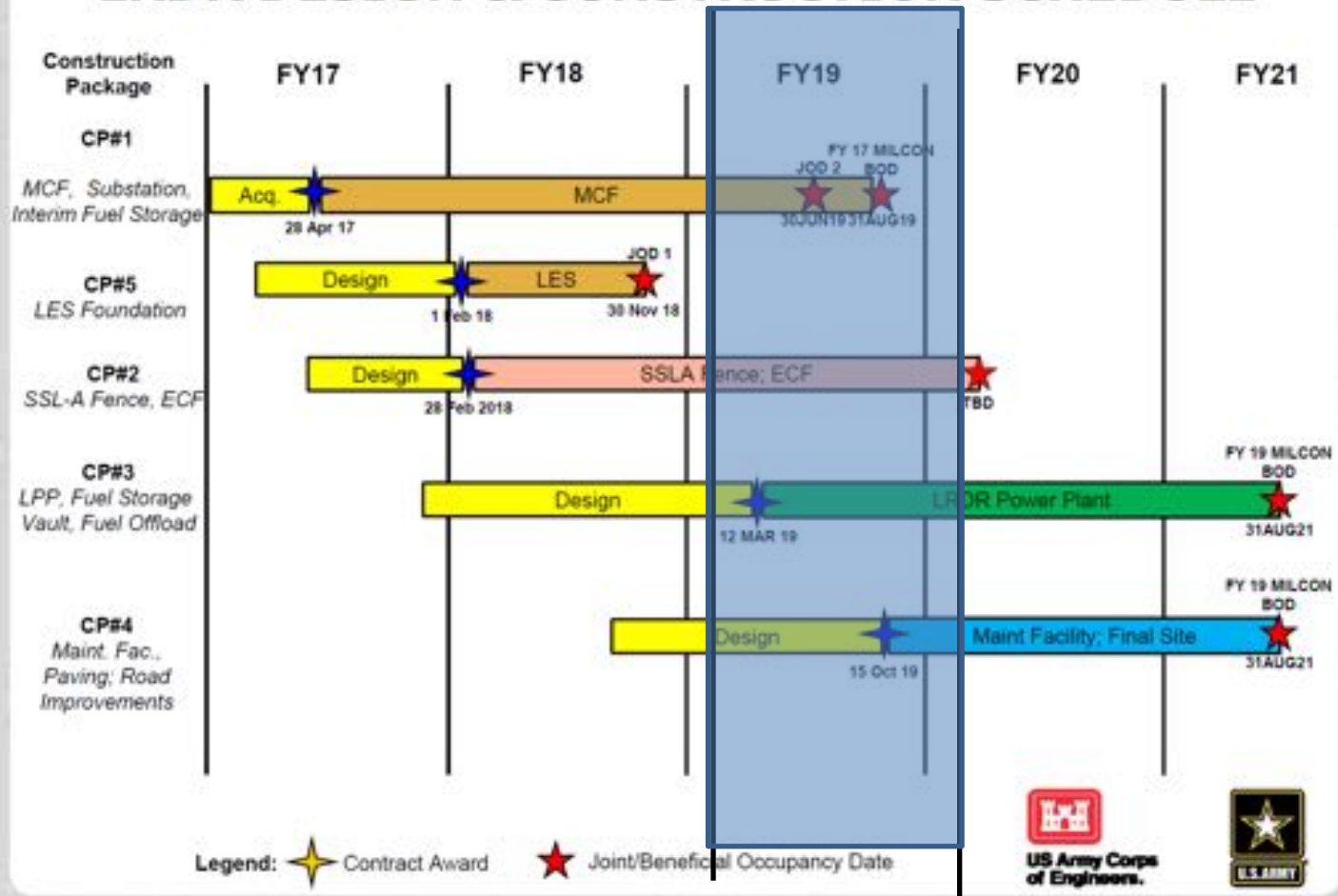

METAL PRICES (30 YEARS)

Gold Price
1,302.78 USD/ozt
28 Jan '19

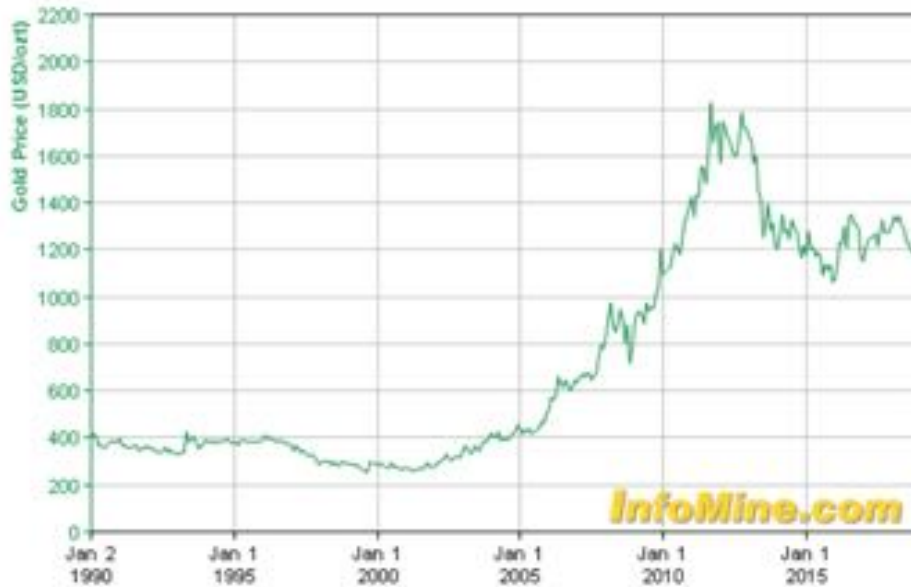

Zinc Price
1.18 USD/lb
24 Jan '19

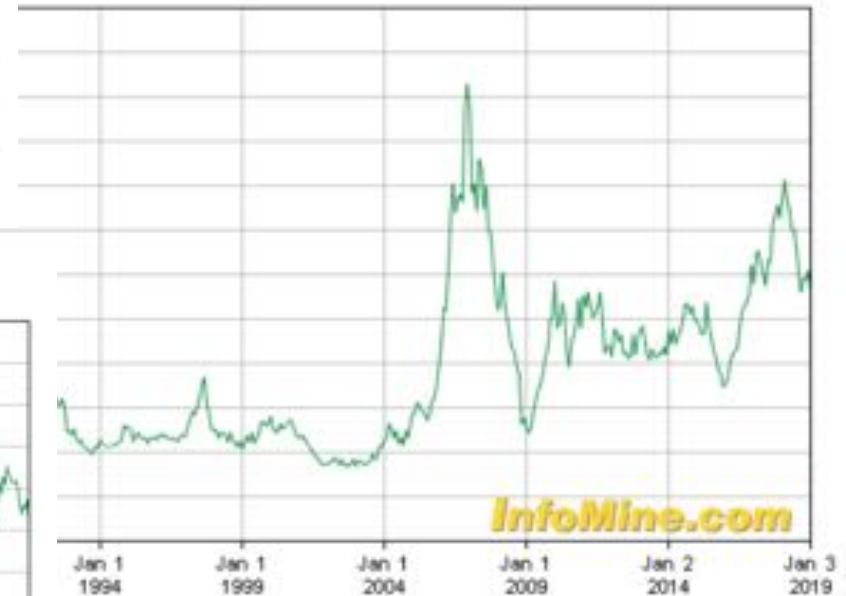

Copper Price
2.74 USD/lb
25 Jan '19

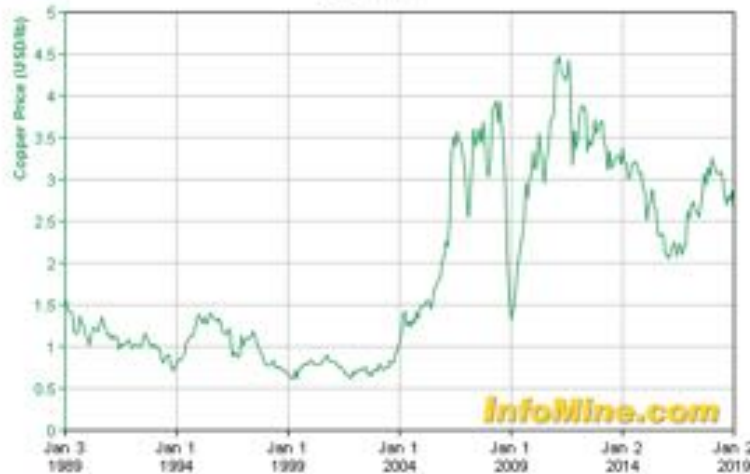

Signs of Life?



State Govt Capital Appropriation: From Own Sources (Million 2018 \$)

■ GENERAL FUND ■ OTHER ■ GO BONDS

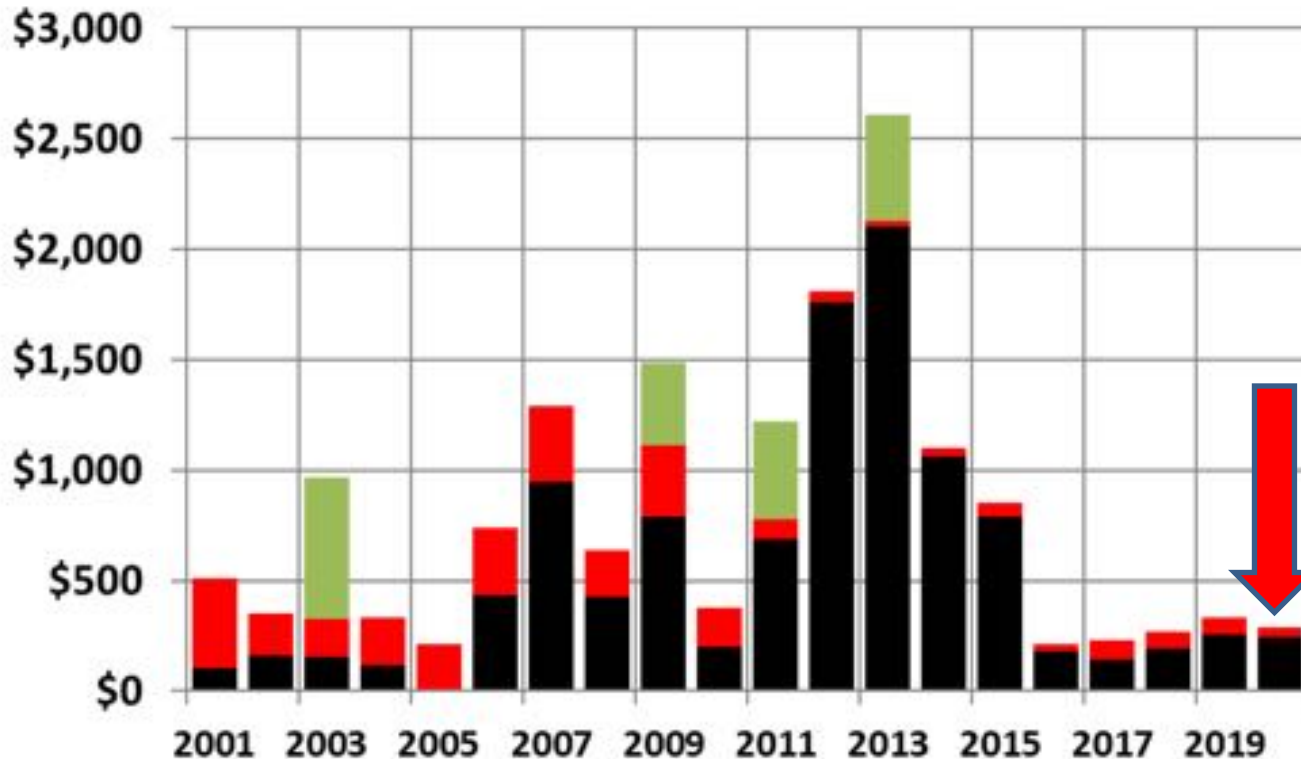

AVERAGE = \$800 Million



What's a Reasonable Capital Budget from State Funds?

- ✓ Federal Match
- ✓ Deferred Maintenance--Current
- ✓ Deferred Maintenance--Backlog
- ✓ K-12 Education
- ✓ Local Infrastructure Needs
- ✓ Economic Development



2019

ALASKA'S CONSTRUCTION SPENDING FORECAST



Questions?



BY SCOTT GOLDSMITH
INSTITUTE OF SOCIAL AND ECONOMIC RESEARCH
UNIVERSITY OF ALASKA ANCHORAGE

